



460 Southport Commerce Blvd.
 Spartanburg SC 29306
 Phone: 864-574-6004
 Fax: 864-574-6005
 www.ojedausa.com
 sales@ojedausa.com

Project: _____
 Model #: _____
 Item #: _____ Qty: _____
 Approval: _____

CHEST FREEZER

NCFH-28



ADJUSTABLE THERMOSTAT
 Freezers are equipped with a mechanical thermostat that allows the users to adjust temperature that best fits their products needs. Set from factory at -4°F.

STEEL CONSTRUCTION
 Robust steel construction minimizes the use of plastic materials resulting in an environmental friendly design.

LID LOCK
 Equipped with a security lock (standard).

FOAMED DOOR
 Solid chest freezer door with a perfect closing seal. The location of the equipment must allow at least a 75° opening angle.

OPERATING TEMPERATURE
 0° - -10°F (-18° - -23°C)

CUSTOM GRAPHICS
 Standard color: white

Dimensions			Crated Dimensions			Baskets	HP	Voltage	NEMA config	Amps	Crated Weight		
	W	D	H		W	D	H	1	1/5	120	5-15P	3.5	103 lbs
(in)	26.8	27.1	34	(in)	28.9	28	36.3	Net Capacity (cf): 5.75			Energy Consumption: 1.47 kw-hr/day		
(mm)	680	687	862	(mm)	733	709	920						

*Inches rounded up one decimal place *Specifics may change without notification



OPERATING CONDITIONS

- The unit is best suited for an environment where temperatures remain below 85 F and humidity does not exceed 55%
- Areas with direct sunlight should also be avoided

WARRANTY

- 3 year parts and labor warranty
- 5 year compressor part

CABINET CONSTRUCTION

- High-density, CFC-Free, polyurethane insulation
- Exterior: Galvanized metal cabinet with powder coated painted surface
- Interior: Easy to clean pre-painted steel
- Heavy Duty Casters
- Drain plug for easy cleaning

REFRIGERATION

- Maintenance free condenser
- Adjustable Thermostat
- Easy to reach components for maintenance
- Triple access air flow compressor compartment.

BASKETS

- Removable Wire baskets

STANDARD UNIT LOCK



HINGE



REMOVEABLE GASKET



HEAVY DUTY CASTERS



REMOVEABLE BASKETS

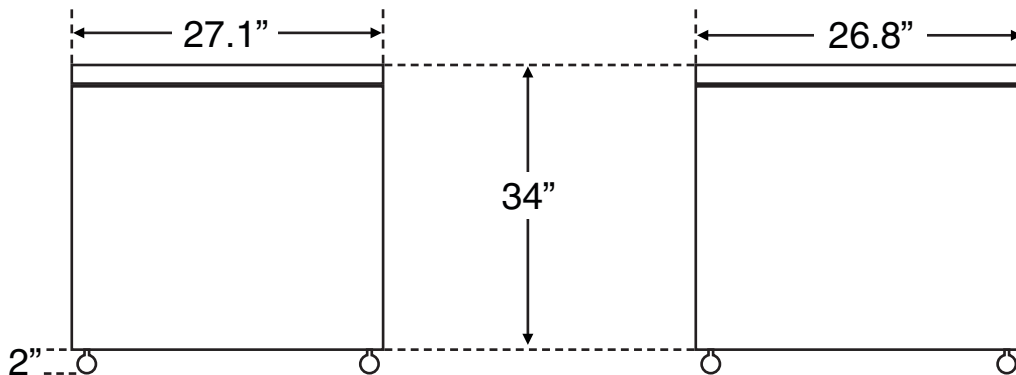
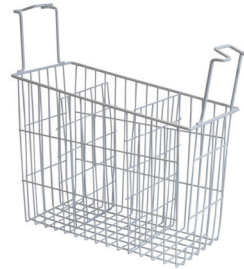

*Specifics may change without notification

